

MLT 625

AGRICULTURAL HANDLING solution



 **MANITOU**

A COMMITMENT TO FARMING



Manitou have been closely associated with agriculture for more than 20 years, we know your business is both **ever-changing** and **demanding**, we fully understand your needs so you can be sure you'll be able to find the Manitou you need from our extensive farming range.

The MLT 625 rough terrain telescopic handler is a machine ideally suited for you and has been developed with ultra compact dimensions. It will enable you to carry out all your **farm handling**

operations: animal feed, bale handling, bulk loading and unloading.

Dairy and livestock farms, nurseries, poultry or any operation where space is restricted, you will appreciate all the qualities of this machine. More than just a handling solution, Manitou offers you a machine which both looks good and is comfortable to use: the interior and exterior have incorporated the latest modern design technology. The MLT 625 includes the benefits and features of recent innovations from the Manitou design team: JSM*, new cab and ECS**, enabling you to work in **comfort and to maximum productivity**.

When you choose Manitou, you can rely on a machine with a high level of performance. You also benefit from all the services offered by your local Manitou dealer: After-sales service, maintenance contracts, on-site repairs, personalised leasing and finance solutions.

Like you, we are dedicated to agriculture.



* Joystick Switch and Move, patent applied for by Manitou BF
** Easy Connect System: hydraulic changeover of the accessory line, standard on the Premium version



“A unique farm handling solution”

YOU WILL BE IMPRESSED...

1 m 82 x 2 m:

Ultra compact dimensions to easily access the most confined spaces.

18 inch:

Agricultural profile tyres... specifically for farming applications!

38 cm:

Ground clearance to get you out of any situation.



Compact?... Super compact!

Super compact dimensions to access the most restricted area. At less than 2m high and 1.82m wide, the MLT 625 can easily enter your buildings and operates in areas which are inaccessible to other machinery.



Modern Technology

Because you appreciate machines that look good, the design of the MLT625 incorporates the latest modern machinery styling techniques.

Goes anywhere

In addition to its ground clearance of 38 cm, the MLT 625 is fitted with 18" agricultural profile tyres. The excellent traction and grip allows the machine to operate on all types of terrain. You can work in any situation and versatility becomes part of your daily life.

YOU WILL FEEL COMFORTABLE...



Farming has changed a lot, so has handling.

The interior of the MLT 625 offers high levels of comfort and design. The driving position has been ergonomically designed to maximise your productivity: it is fitted with a cloth seat and a fully adjustable steering column. Ventilation outlets, sun visor, roof screen, airconditioning, etc. all help to provide you with a comfortable working environment.

Exclusive to Manitou, **JSM** allows you to control all your movements with one hand in total safety and without causing fatigue: raising and lowering the boom, telescoping and retracting the boom, tilting and tipping, plus an auxiliary service for attachment and forward/reverse travel direction. You always keep one hand on the steering wheel to maintain full control of your MLT.

Low noise levels and improved driver productivity is achieved due to the full **soundproofing** of the cab (only 76dB) and engine compartment areas.

The dashboard has a **digital** display which gives all the information you need during your working day: hour meter, speed, travel direction, maintenance reminder.

A compact machine with a spacious cab, we have not compromised the space you have available: you will feel at ease in your cab and appreciate the time spent at the controls of your MLT 625.



“ you will be more productive! ”

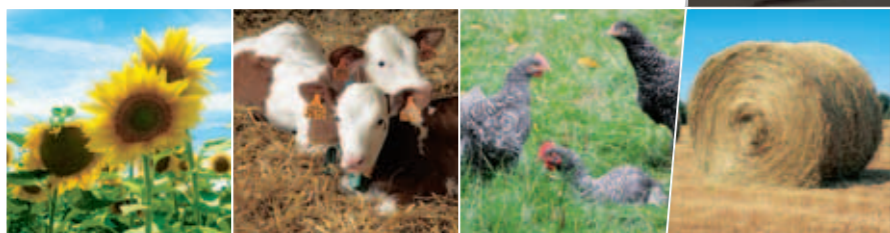

“Adapting to your requirements”

EACH TO THEIR OWN **NEEDS**

Adapting to your requirements. That's the reason you **can choose between** 2 levels of finish: **Classic** and **Premium**.



CLASSIC

Manitou provides you with complete peace of mind with the classic version of the MLT 625.

In the **Classic version**, your comfort is increased by:

- Cloth-covered mechanical seat
- Rear-view mirror
- Car radio
- Automatic radiator cleaning system

PREMIUM

You don't just choose Manitou, you choose the Manitou **to suit you...** Higher specification **premium** model available with additional features:

- Pneumatic seat
- CD/MP3 car radio
- Air conditioning
- Rear-view mirror
- Easy Connect System
- Automatic radiator cleaning system

You will really appreciate the time spent in your MLT 625.



POWER AND PERFORMANCE

“Optimising the power of your engine”

Each telehandler must have a **suitable power unit** to give you the best engine/machine torque: too little power and you lose efficiency; too much power could increase consumption to no effect.



The **Kubota 4 cylinder Turbo 75 hp** (54.5 kW) is ideally suited for maximum engine efficiency. The MLT 625 is perfectly adapted with a power/weight ratio giving you exceptional performance and fuel consumption from the fully flexible **hydrostatic transmission**.

All the drive line components of your machine (power unit, transmission, axles, hydraulics and tyres) are combined to optimise the power produced by your engine.

In travel mode, the precision of the **2-speed mechanical gearbox** allows you to travel at speeds up to 25 mph.

75 hp:

The 75 hp of your MLT 625 gives you efficient fuel consumption thanks to its ideal power/weight ratio.

2 speed hydrostatic transmission:

Flexibility and precision are important factors with the 2-speed hydrostatic transmission allowing change on the move.

“Fast work cycles for maximum efficiency”



YOU WILL HAVE TIME TO SPARE

Save yourself time to concentrate on what matters - that's Manitou's philosophy when it comes to handling.

The **90 litre/235 bar** hydraulic gear pump provides high flow hydraulic performance for a machine of its class. Combined with JSM it enables you to achieve fast working cycles.

For **maximum productivity** Manitou offers you a machine which is simple to use. **Ergonomically designed JSM control, with all functions perfectly placed for total precision and efficiency for all your handling duties.**

Manoeuvrability is your priority! The MLT 625 can fully access the majority of your working environment. With four wheel steering, the compact dimensions of your machine and its excellent turning circle makes it easy to fulfil your daily tasks.

A full range of attachments are available to increase the utilisation of your MLT 625. Whatever the job, the MLT 625 has an attachment to suit, increasing the versatility of your machine.



Work cycle times

Movement	Time
RAISE BOOM	7.20 s
LOWER BOOM	4.90 s
EXTEND TELESCOPE	5.20 s
RETRACT TELESCOPE	3.70 s
TILT FORWARD	3.20 s
TILT BACK	3.20 s

21 seconds:

Your MLT 625 allows you to carry out a full work cycle in only 21 seconds.

4x4x4:

4 wheel drive and 4 wheel steer = manoeuvrability for maximum agility.

90 l/min:

The hydraulic gear pump, combined with the JSM, delivers a maximum flow rate of 90 l/min for easy and accurate movements.

YOU ARE SAFE

DESIGNED WITH YOU IN MIND

Our **design department**, employing more than 200 engineers and technicians, have specialised in the design of agricultural telehandlers **for more than 20 years**. With more than 50 registered patents, our knowledge and expertise with regard to all aspects of machinery design offers you reliability and durability.

Specialists in the agricultural market, we fully understand the working life of your machines and develop new products accordingly.



“The assurance of working **in total safety**”

YOU ARE PROTECTED

Your working environment must be a safe area

The excellent **stability** of the MLT625 combined with the aggravating movement device allows you to handle loads up to **2.5 tonnes** with complete confidence.

Your **safety** is further enhanced by the operator **presence detector** located in the seat. Travel movements are only allowed when you are sitting in the driving seat.

The cab has been especially designed to **protect** you. Satisfying **ROPS/FOPS*** requirements, for roll over protection and falling objects protection.

360° all round visibility gives you unrivalled vision providing a safe working environment.

* ROPS: rollover protection structure
FOPS: falling objects protection structure



THE BACK UP YOU WOULD EXPECT

OFFERING YOU **BESPOKE** SERVICES

Your nearest Manitou dealer has all the necessary expertise.

Manitou has a dedicated network of dealers, strategically located to offer a first class back up service. The experience and commitment of Manitou at more than 500 dealers throughout the world, ensure you can rely on professional support on a daily basis.

Maintenance and after-sales service: to get the most out of your machine, your Manitou dealer can offer you maintenance contracts. You will reduce your usage costs and have the peace of mind that your equipment is being regularly monitored. Your Manitou dealer is committed to increase your productivity.

Leasing and finance agreements: can provide flexible finance solutions, we help provide you with specific finance and modular solutions to support you as your business develops.

- **COMFORT SERVICE:** a maintenance contract comprising consumables, labour and travel for maximum peace of mind.
- **MANIPLUS:** a contract which extends the manufacturer's guarantee by 24 to 36 months.

“Adapting to
an ever changing
world”



REDUCE YOUR **ECOLOGICAL FOOTPRINT**

From the design stage of your machine, Manitou plays an active role in respecting **the environment**.

We have a sincere respect for our environment. Our production site is certified **ISO 14001***, this guarantees that environmental standards are included from the design stage of the product up to the delivery of the machine to your business.

The optimum management of the engine speed according to the power demanded **minimises your consumption** and your polluting emissions, thus reducing the impact of the use of your MLT 625 on the environment.





* ISO 14001: international environmental management standard which details requirements relating to the implementation of an environment management system.

YOUR CHOICE



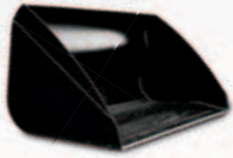







Standard and optional equipment	CLASSIC	PREMIUM
Fork carriage	●	●
Air conditioning	○	●
Cloth seat	●	-
Pneumatic cloth seat	○	●
Rear-view mirror	●	●
Easy Connect System	○	●
CD/MP3 car radio	○	●
Radio/CD player	●	-
Automatic radiator cleaning system	●	●
Hand throttle	○	○
Electric rear window de-misting	○	○
Windscreen Guard	○	○
Continuous flow hydraulics	○	○
Flow control system	○	○
Boom working lights	○	○
Blue poultry lights	○	○
Hydraulic locking (accessories)	○	○
Electric prewriting at the boom head	○	○
Free flow return	○	○
Rear clevis hitch	○	○

● Standard ○ Option - Not available

Selection of attachments:

		
Bucket with grab	Grain bucket	Sweeper-collector
		
Auger/feed bucket	Pressure washer	

MLT 625-75 H

	Lifting capacity at 500 mm from forks heels Break out force as per standard ISO 8313-1986	2500 kg 4205 daN
	Lifting height Time: laden/unladen (in s)	5.90 m
	Lifting	7.2/7.45
	Lowering	4.90/5
	Telescope	
	Extension	5.2/5.3
	Retraction	3.7/3.75
	Time: unladen (in s)	
	Crowd	3.2
	Dump	3.2
	Front/rear tyres	12.0-18 12 PR
	Forks (mm)	
	Length	1200
	Width x thickness	125 x 45
	Oil immersed multidisc brake	
	KUBOTA engine	
	Type	V3307-DI-T-E3B
	Capacity	4 cyl./3331 cm ³
	Power (ISO/TR 14396)	75 HP/55.4 kW Turbo
	Max. torque (ISO/TR 14396)	265 Nm at 1400 tr/mn
	Injection	direct
	Cooling	water
	Transmission	hydrostatic
	Gear reverser	electro-hydraulic
	Speed forward and reverse	2/2
	Max. travel speed up to	25 km/h
	Hydraulics	
	Gear pump	90 l/min at 235 bars
	Flow divider priority for steering	
	Capacities	
	Cooling system	12 l
	Transmission oil	115 l
	Engine oil	11.2 l
	Fuel tank	63 l
	Unladen weight (with forks)	4922 kg
	Overall Width	1.82 m
	Overall Height	2.00 m
	Turning radius (outer wheels)	3.19 m
	Length at carriage	3.90 m
	Ground clearance	0.38 m

Maximum height reach: 0.50 m

As per standard EN 1459 annex B

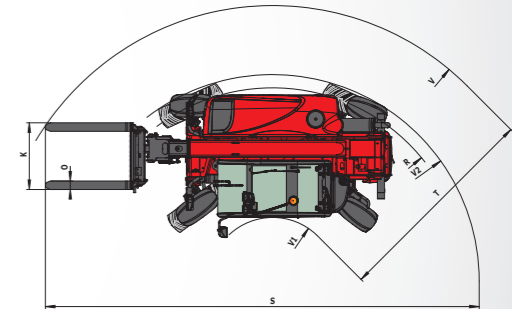
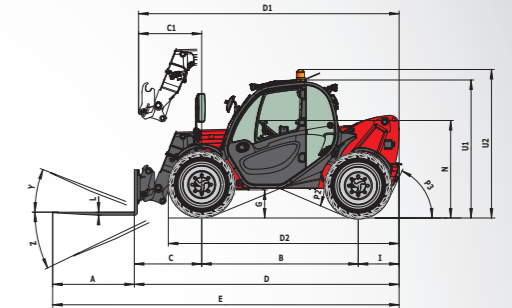
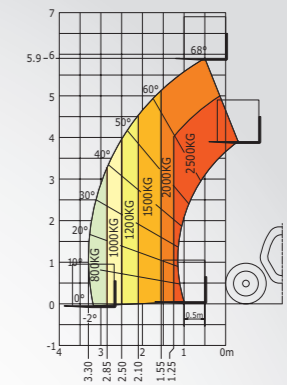

A	1200
B	2300
C	991
C1	928
D	3894
D1	3831
D2	3393
E	5094
F	1500
F1	1500
G	378
I	603
J	797
K	1015
L	45
N	1398
O	125
P2	45
P3	65
R	3033
S	6531
T	3475
U1	2000
U2	2167
V	4240
V1	765
V2	3190
W	1814
Y	12°
Z	117°
	mm

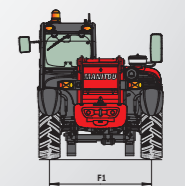
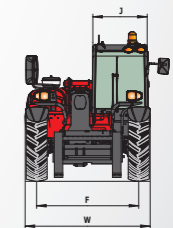

Your nearest **MANITOU** dealer:



 **MANITOU**

Head office:

B.P. 249 - 430 rue de l'Aubinière - 44158 Ancenis Cedex - France

Tel: 00 33 (0)2 40 09 10 11 - Fax: 00 33 (0)2 40 09 10 97

www.manitou.com

CE This brochure describes versions and configuration options for Manitou products which may be fitted with different equipment. The equipment described in this brochure may be standard, optional or not available depending on version. Manitou reserves the right to change the specifications shown and described at any time and without prior warning. The manufacturer is not liable for the specifications given. For more information, contact your Manitou dealer. Non-contractual document. Product descriptions may differ from actual products. List of specifications is not comprehensive. The logos and visual identity of the company are the property of Manitou and may not be used without authorisation. All rights reserved. The photos and diagrams contained in this brochure are provided for information only.

MANITOU BF SA - Limited company with board of directors - Share capital: 37,567,540 euros - 857 802 508 RCS Nantes